

USER'S MANUAL

BM887 BM885

Insulation Tester Combination Multimeter



1) SAFETY

This manual contains information and warnings that must be followed for operating the meter safely and maintaining the meter in a safe operating condition. If the meter is used in a manner not specified by the manufacturer, the protection provided by the meter may be impaired.

Terms in this manual

WARNING identifies conditions and actions that could result in serious injury or even death to the user.

CAUTION identifies conditions and actions that could cause damage or malfunction in the instrument.

WARNING

To reduce the risk of fire or electric shock, do not expose this product to rain or moisture. The meter is intended only for indoor use.

Observe proper safety precautions when working with voltages above 33 Vrms, 46.7 Vpeak or 70 VDC. These voltage levels pose a potential shock hazard to the user. Before and after hazardous voltage measurements, check the voltage function on a known source such as line voltage to determine proper meter functioning.

The meter meets UL/IEC/EN61010-1 Ed. 3.0, CAN/CSA C22.2 No. 61010-1 Ed. 3.0, UL/IEC/EN61010-2-033 Ed. 1.0 to Measurement CAT-III 1kV and CAT-IV 600V, AC & DC. The meter also meets the relevant Parts of EN61557. In particular, Part 1 Ed. 2.0, Part 2 Ed. 2.0 and Part 10 Ed. 2.0. These relevant parts of EN61557 are not covered by the ETL certification.

The accompanied test probe assembly meets UL/IEC/EN61010-031 Ed. 1.1 to the same meter ratings or better. IEC 61010-031 requires exposed conductive test probe tips to be $\leq 4\text{mm}$ for CAT III & CAT IV ratings. Refer to the category markings on your probe assemblies as well as on the add-on accessories (like detachable Caps or Alligator Clips), if any, for applicable rating changes.









Keep your hands/fingers behind the hand/finger barriers (of the meter and the test probe assembly, where applicable) that indicate the limits of safe access of the hand-held parts during measurements. Inspect lead wires, connectors, and probes for damaged insulation or exposed metal before using the meter. If any defects are found, replace them immediately. Only use the probe assembly provided with the meter or a

UL Listed Probe Assembly to the same meter ratings or better.

CAUTION

Disconnect the test leads from the test points before changing functions.

International Electrical Symbols

	Marking of Electrical and Electronic Equipment (EEE). Do not dispose of this product as unsorted municipal waste. Contact a qualified recycler
	Caution! Refer to the explanation in this Manual
	Caution! Possibility of electric shock
	Earth (Ground)
	Meter protected throughout by Double Insulation or Reinforced insulation
	Fuse
	Direct Current (DC)
	Alternating Current (AC)
	Three-phase Alternating Current

Brief Information about Measurement Categories

Measurement Category IV is applicable to test and measuring circuits connected at the source of the building's low-voltage MAINS installation. Examples are measurements on devices installed before the main fuse or circuit breaker in the building installation.

Measurement Category III is applicable to test and measuring circuits connected to the distribution part of the building's low-voltage MAINS installation. Examples are measurements on distribution boards (including secondary meters), circuit-breakers, wiring, including cables, bus-bars, junction boxes, switches, socket-outlets in the fixed installation, and equipment for industrial use and some other equipment such as stationary motors with permanent connection to the fixed installation.

Measurement Category II is applicable to test and measuring circuits connected directly to utilization points (socket outlets and similar points) of the low-voltage MAINS installation. Examples are measurements on MAINS CIRCUITS of household appliances, portable tools and similar equipment.

2) CENELEC DIRECTIVES

The instruments conform to CENELEC Low-voltage directive 2014/35/EC, Electromagnetic compatibility directive 2014/30/EU and RoHS directive 2011/65/EU.

3) PRODUCT DESCRIPTION

Note: Top of the line model is used as representative for illustration purposes. Please refer to your particular model for function availability.

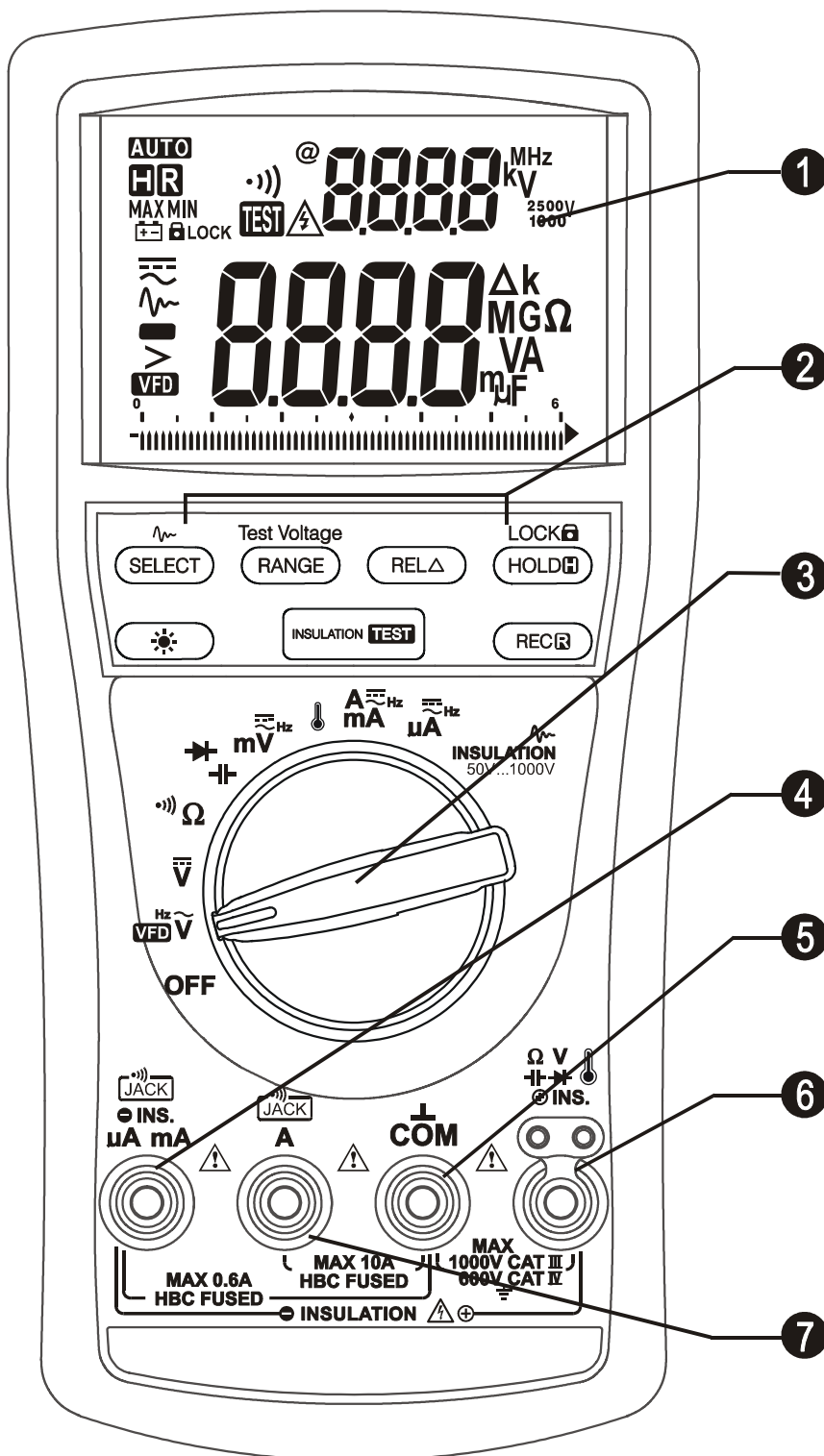

1) 3-5/6 digits 6000 counts dual displays

2) Push-buttons for special functions & features

3) Selector to turn the Power On or Off and Select a function

4) Input Jack for Insulation function Ground reference
 ● **INS.** or mA/μA function positive input

5) Common (Ground reference) Input Jack for all functions *EXCEPT* Insulation Resistance function

6) Input Jack for all functions *EXCEPT* A, mA and μA functions

7) Input Jack for A function positive input

Analog bar-graph

The analog bar graph provides a visual indication of measurement like a traditional analog meter needle. It is excellent in detecting faulty contacts, identifying potentiometer clicks, and indicating signal spikes during adjustments.

4) OPERATION

CAUTION

Before and after hazardous voltage measurements, test the voltage function on a known source such as line voltage to determine proper meter functioning.

ACV ^{+Hz} & VFD ACV ^{+Hz} functions

Press the **SELECT** button momentarily to toggle the subject functions. Last selection will be saved as power up default for repeat measurement convenience. For **ACV ^{+Hz}** function, press the **RANGE** button momentarily to select other ranges manually when needed. For **VFD ACV ^{+Hz}** function, only 600V range is provided to best cope with the measurements of most Variable Frequency Drives (VFD).

To select **DCV** function, turn the Rotary Knob to **DCV** position for measurements.

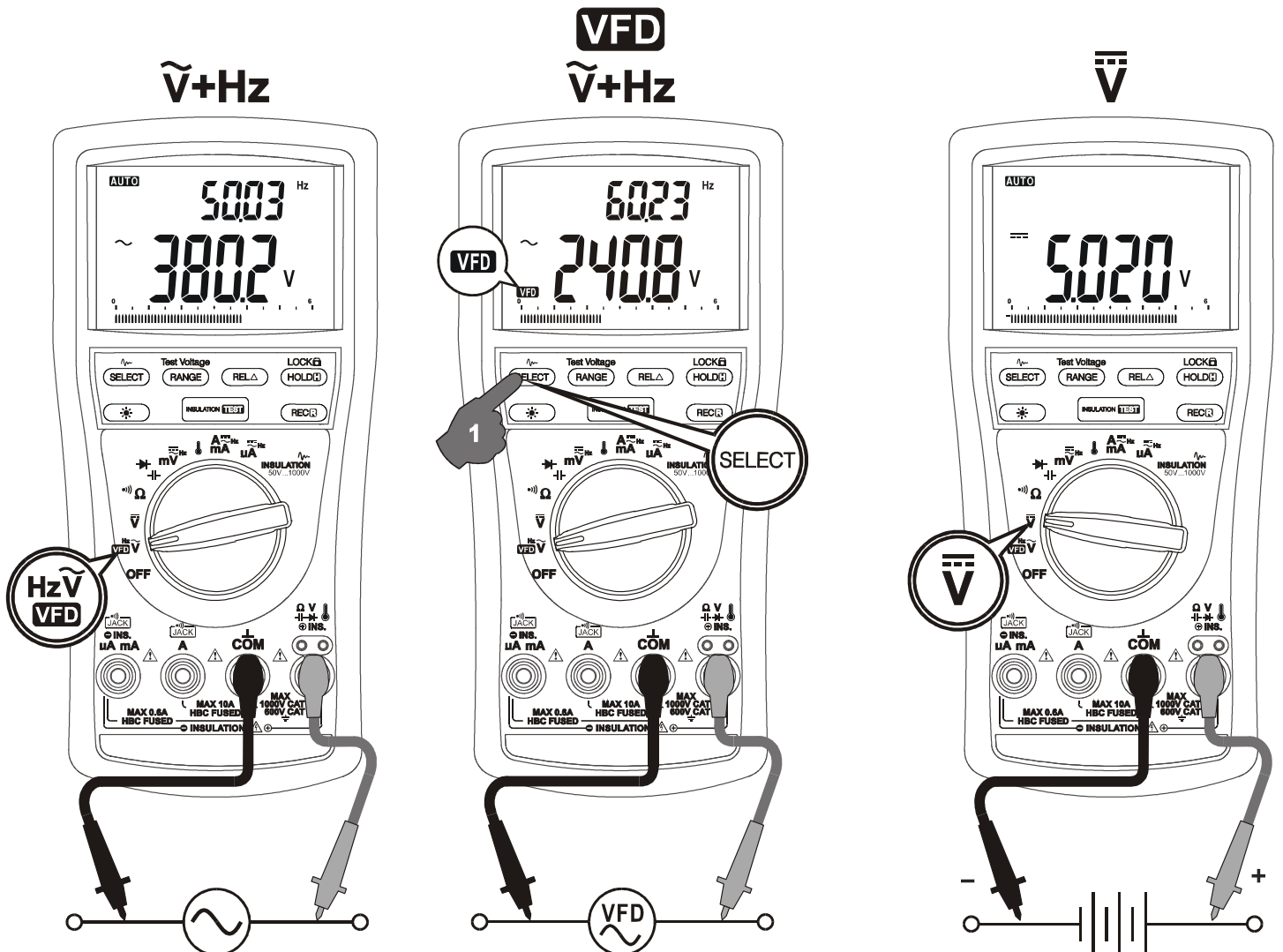

Ω Resistance, $\cdot\cdot\cdot$) Continuity functions

Press the **SELECT** button momentarily to toggle the functions. Last selection will be saved as power up default for repeat measurement convenience. $\cdot\cdot\cdot$) Continuity function is convenient for checking wiring connections and operation of switches. A continuous beep tone indicates a complete wire.



CAUTION

Using resistance or continuity function in a live circuit will produce false results and may damage the instrument. In many cases the suspected component must be disconnected from the circuit to obtain an accurate reading

Auto leads resistance calibration

When entering the **60 Ω** range *manually* by **RANGE** button for high precision low resistance measurement, this feature will prompt you to short the inputs for temporary test lead resistance calibration on this range.

The fastest way is to short the leads to auto-range to the **60 Ω** range, then press the **RANGE** button momentarily. The display shows "**Shrt**". Keep shorting the leads for further 3 seconds until the display shows zero. The lead resistance is then temporarily compensated.

The compensation value stays until the next meter power reset, and can be as high as 5Ω. If you need a compensation value that is higher than that, Relative Zero mode is recommended.

➔ Diode Test, ⇄ Capacitance (Model 887 only) functions

Press the **SELECT** button momentarily to toggle the functions. Last selection will be saved as power up default for repeat measurement convenience.

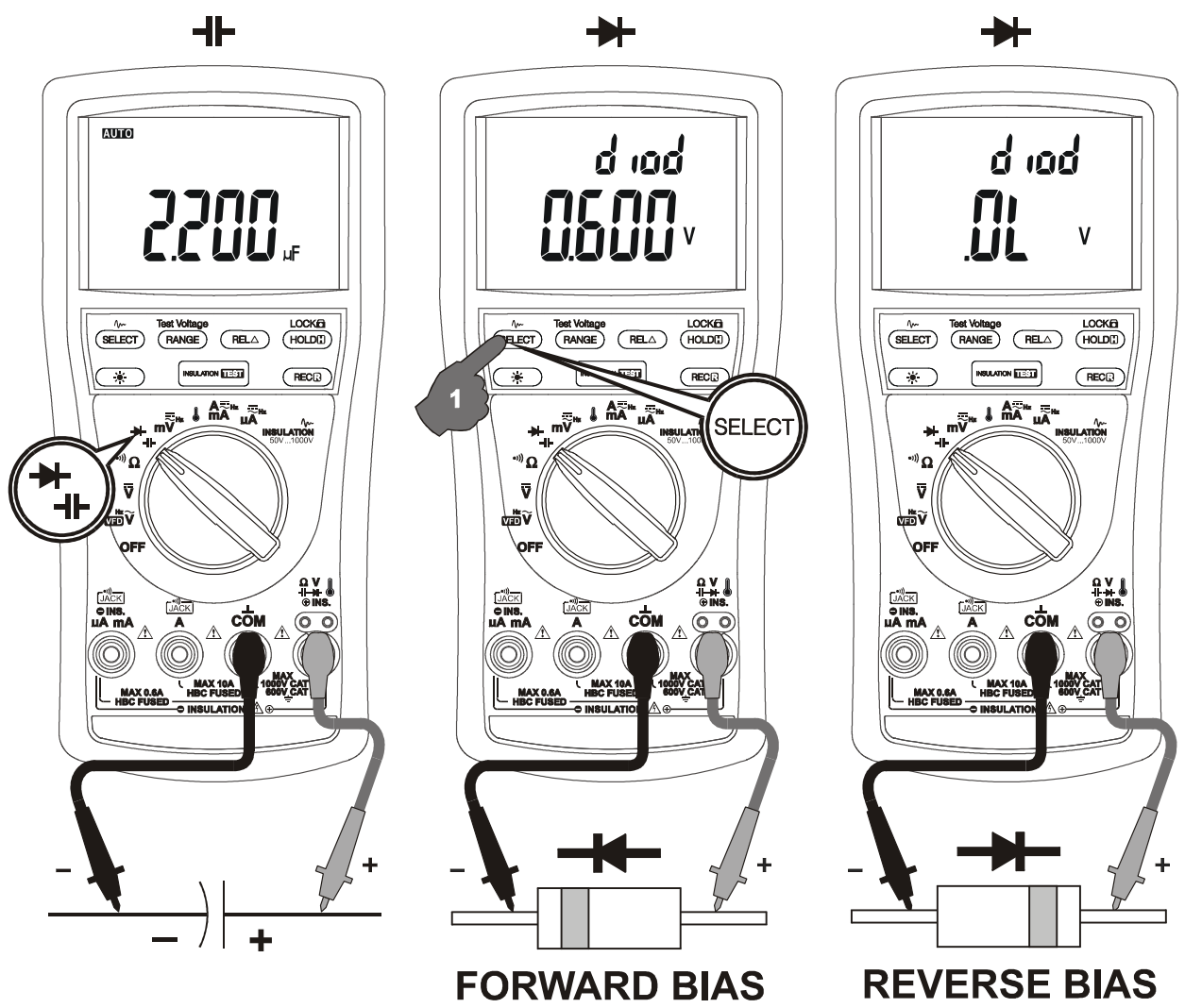

CAUTION

Discharge capacitors before making any measurement. Large value capacitors should be discharged through an appropriate resistance load.

Normal forward voltage drop (forward biased) for a good silicon diode is between 0.400V to 0.900V. A reading higher than that indicates a leaky diode (defective). A zero reading indicates a shorted diode (defective). An OL indicates an open diode (defective). Reverse the test leads connections (reverse biased) across the diode. The digital display shows OL if the diode is good. Any other readings indicate the diode is resistive or shorted (defective).

DCmV, ACmV +Hz functions

Press the **SELECT** button momentarily to toggle the subject functions. Last selection will be saved as power up default for repeat measurement convenience.

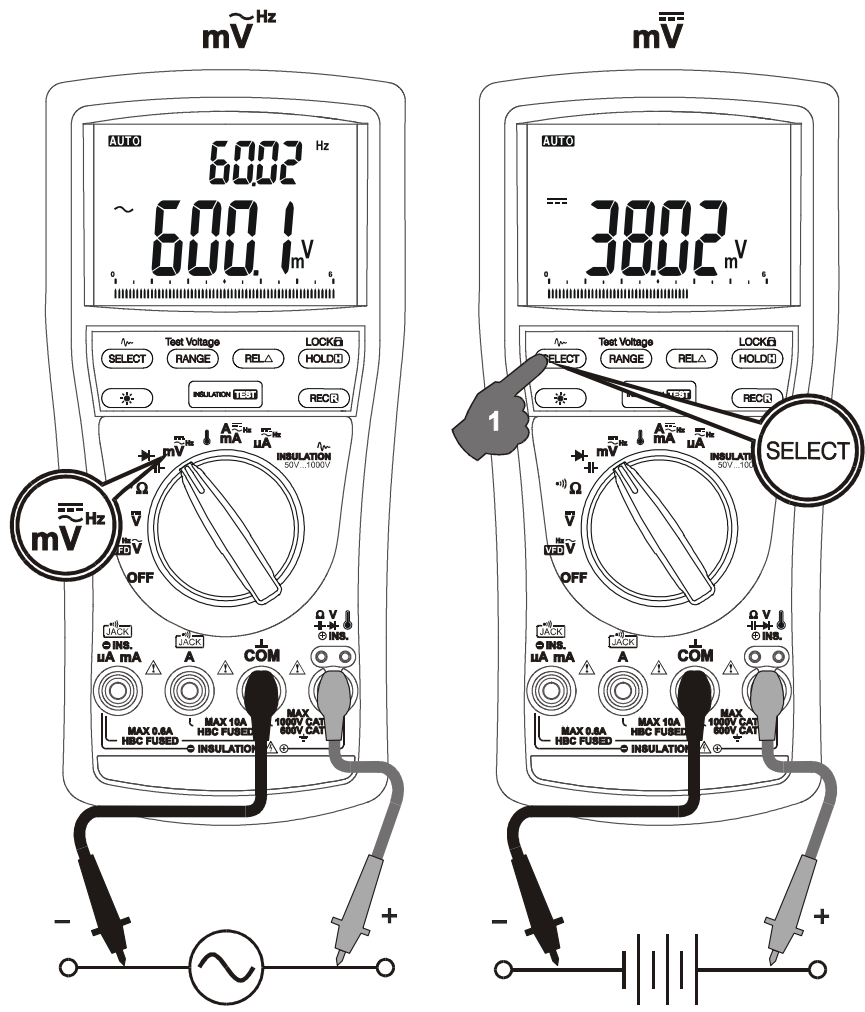

Temperature functions (Model 887 only)

Press **SELECT** button momentarily to toggle °C and °F readings. Last selection will be saved as power up default for repeat measurement convenience.

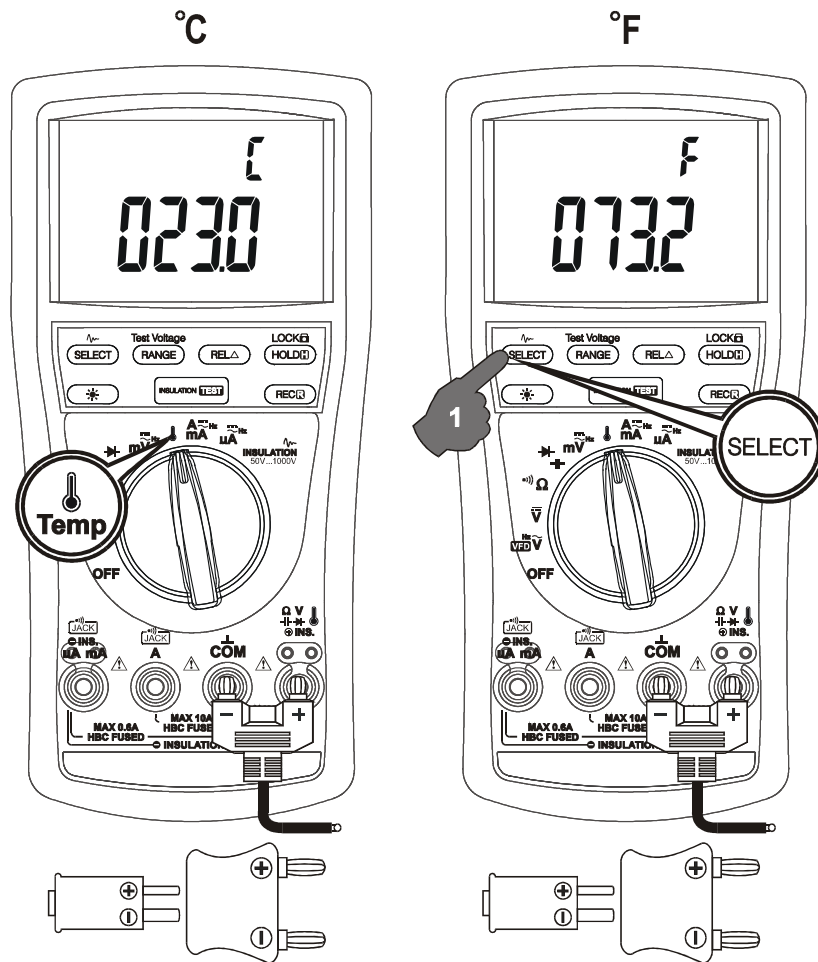

Note: Be sure to insert the banana plug type-K temperature bead probe Bkp60 with correct **+** **-** polarities. You can also use a plug adapter Bkb32 (Optional purchase) with banana pins to type-K socket to adapt other standard type-K mini plug temperature probes.

A, mA, μ A Current functions

Press the **SELECT** button momentarily to toggle the **DC** or **AC^{Hz}** of the subject functions. Last selection will be saved as power up default for repeat measurement convenience.

For Model 885, **A** and **mA** functions are at different Rotary Switch positions.

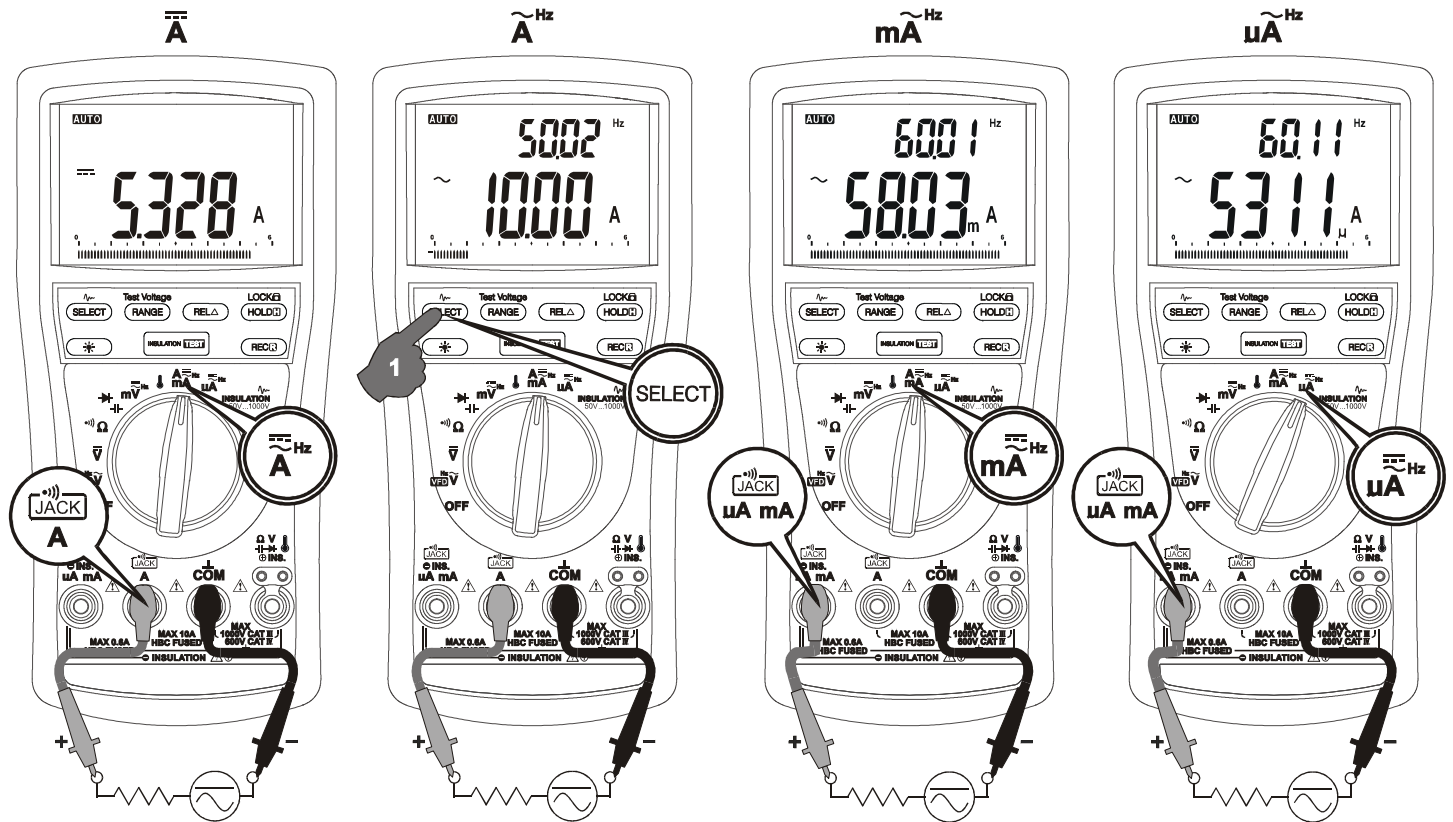

Insulation Resistance function

WARNING

The two LCD icons **TEST** & \triangle used together, throughout in this manual, is referred as active measurements of Insulation Resistance function through the activation of the **TEST** button on the meter or on the Remote Probe. The **TEST** \triangle sources a user selectable test voltage of 50V, 100V, 250V, 500V or 1000V to measure Insulation Resistance values. The \triangle in a flashing manner warns against such test voltage is being output. Use extreme caution when operating the **TEST** \triangle to avoid electric shock.

TEST \triangle is inhibited when the meter sounds 3-beeps and displays the detected voltage value plus \triangle warning against an energized circuit of more than 30V is being connected, before the **TEST** \triangle is active. Measurements shall only be carried out on parts of an installation or equipment that are de-energized.

Connecting to energized circuits when the **TEST** \triangle is active will produce false results and may damage the instrument. Always check with voltage functions and remove

power from the circuits before carrying out the **TEST** ⚡.

Setup as illustrated below.



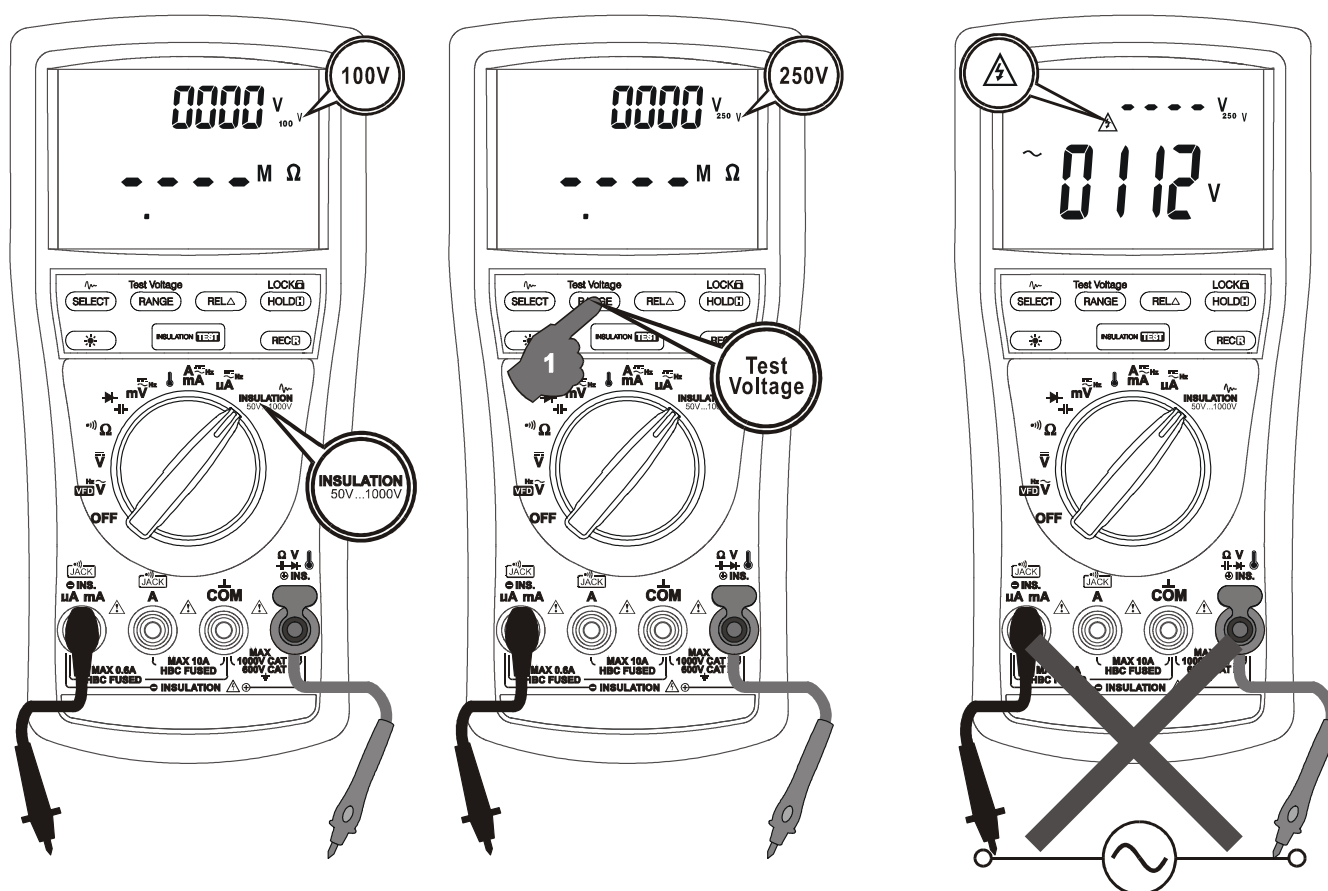

Press the **RANGE** (Test Voltage) button momentarily to select an intended test voltage of 50V, 100V, 250V, 500V or 1000V in sequence. Last selection will be saved as power up default for repeat measurement convenience.

The secondary display shows the selected voltage for 1 second right after the selection, and then displays the actual detected voltage readings. The voltage annunciator by the secondary display remains indicating the voltage selected.



The **TEST** ⚡ is active as long as the **TEST** button is pressed and hold. The **TEST** buttons on the meter and on the Remote Probe work alike. The Insulation Resistance readings are shown on the primary display.



Default startup primary display reading is “-.-.-”. Allow enough **TEST** ⚡ time for a good measuring result. After the **TEST** ⚡ is released, the measuring loop starts to discharge the testing voltage. The last measured resistance reading stays on the primary display until the next **TEST** ⚡ or a function change. The secondary display keeps showing the actual detected voltage readings.

Lock-Test mode is recommended for continuous measurements. To apply, press the **LOCK** button momentarily to display the annunciator  **LOCK** before pressing the **TEST** button momentarily. The LCD will show both  **LOCK** &  **TEST**  to indicate continuous measurement is active. Press again either button momentarily to release the Lock-Test mode.

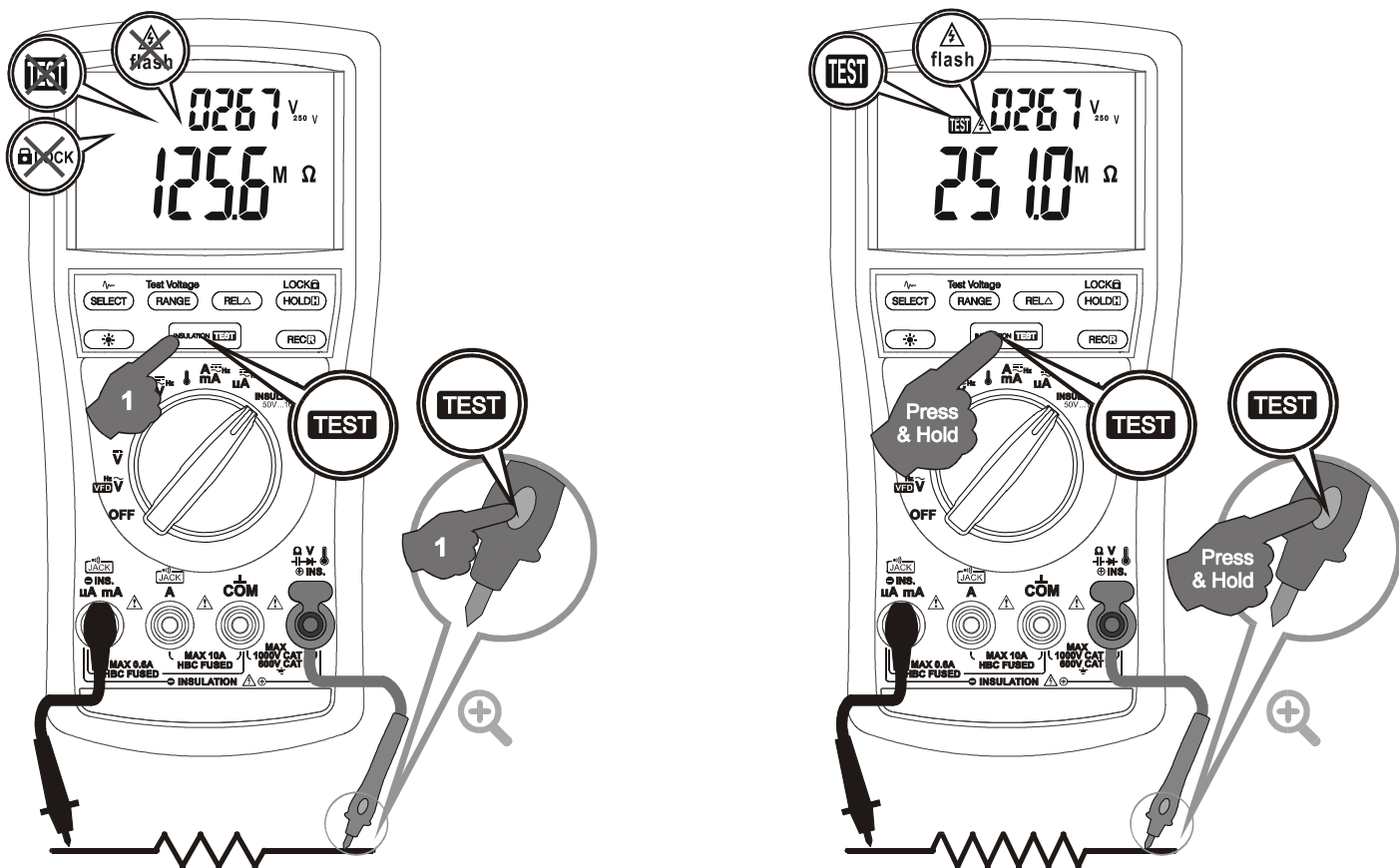
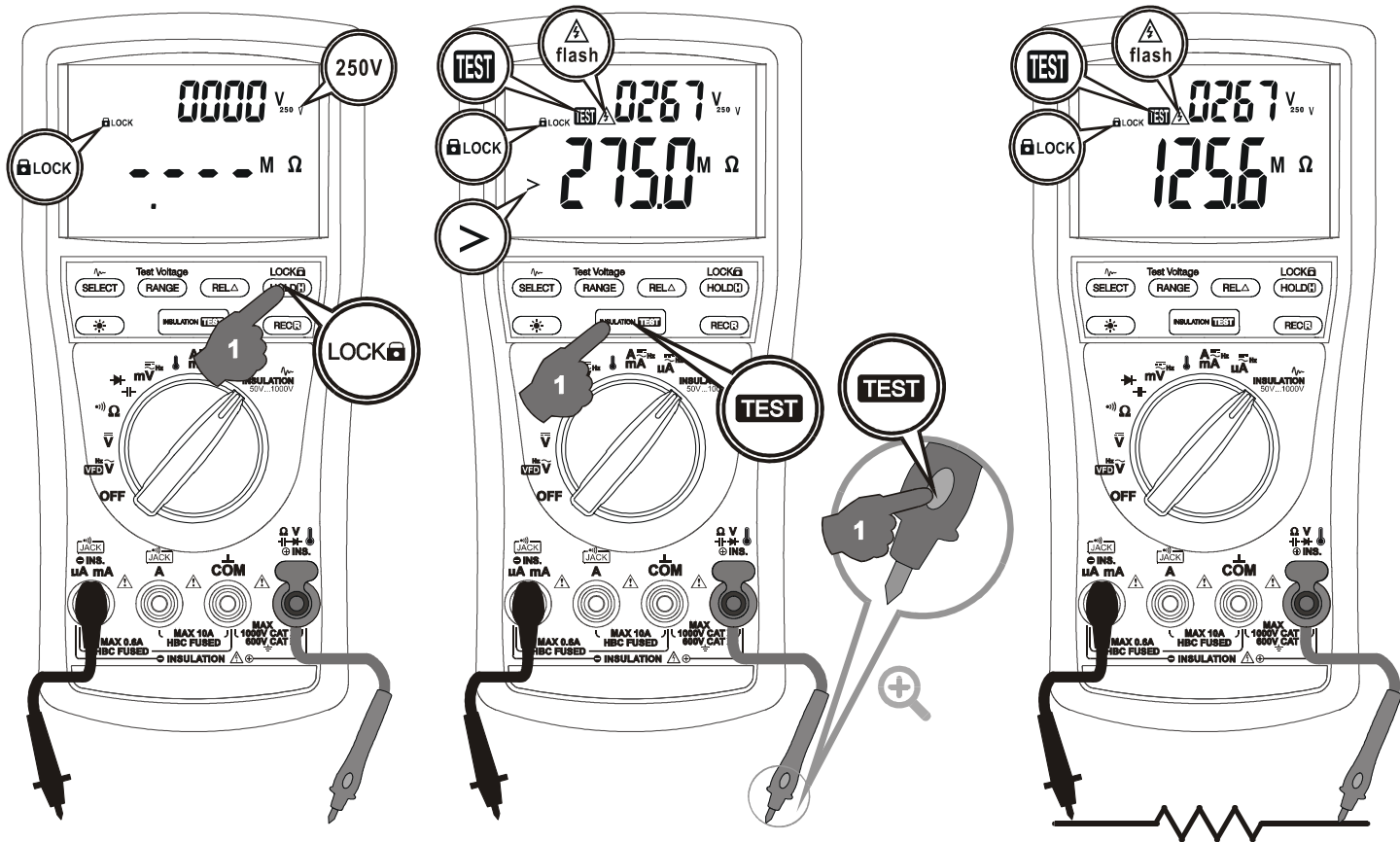
NOTE: Maximum display reading of each Insulation Resistance range is subjected to the test voltage selected. They are 55.0M Ω , 110.0M Ω , 275M Ω , 550M Ω & 25.0G Ω for 50V, 100V, 250V, 500V & 1000V respectively. Over-range is indicated as > maximum-display-reading.



Smooth mode (Insulation Resistance function only)

Smooth  mode displays the running average of the last eight measured readings having changes within 300 counts in sequence. On the contrary, it displays directly, without smoothing, the measured reading that is beyond 300 counts in changes comparing to its former one. Press the  button momentarily to enable with LCD annunciator “” turned on. Press momentarily again to disable.

Backlighting display

Press the  button momentarily to toggle the LCD backlight. The backlight will also be turned off automatically after approximate 10 minutes to extend battery life.

Auto- or Manual-ranging (Volts, Current & Ω functions only)

Press the **RANGE** button momentarily to select manual-ranging, and the meter will remain in the range it was in, the LCD **AUTO** turns off. Press the button momentarily again to select an adjacent range. Press and hold the button for 1 second or more to resume auto-ranging.

Hold

The hold feature freezes the display for later view. LCD “” turns on. Press the **HOLD** button momentarily to toggle the hold feature. This feature does not apply to Insulation Resistance functions.

MAX/MIN Recording mode

Press **REC** button momentarily to activate MAX/MIN recording mode. The LCD “**R**” & “**MAX MIN**” turn on. The meter beeps when a new MAX (maximum) or MIN (minimum) reading is updated. Press the button momentarily to read the Real-time, MAX and MIN readings in sequence. Press the button for 1 second or more to exit MAX/MIN recording mode. When activated, Auto-Power-Off is disabled automatically. This feature does not apply to Insulation Resistance functions.

Relative-Zero (Δ) mode

Relative-Zero allows the user to offset the meter consecutive measurements with the main display displaying reading as the reference value. LCD “ Δ ” turns on. Press the **REL Δ** button momentarily to toggle Relative-Zero mode.

Beep-Jack™ Input Warning

The meter beeps as well as displays “**InEr**” to warn the user against possible damage to the meter due to improper connections to the “ **INS. μ A mA**” or “**A**” input jack when

other functions, especially voltage function, is selected.

Set Beeper Off

Press the **RANGE** button while turning the meter on to temporarily disable the Beeper feature. Turn the rotary switch OFF and then back on to resume.

Auto-Power-off (APO)

The Auto-Power-off (APO) mode turns the meter off automatically to extend battery life after approximately 20 minutes of no rotary switch or push button operations. To wake up the meter from APO, press the **SELECT** or  button momentarily or turn the rotary switch OFF and then back on. Always turn the rotary switch to the OFF position when the meter is not in use.

Disabling Auto-Power-off

Press the **SELECT** button while turning the meter on to temporarily disable the Auto-Power-Off feature. Turn the rotary switch OFF and then back on to resume.

5) MAINTENANCE

WARNING

To avoid electrical shock, disconnect the meter from any circuit, remove the test leads from the input jacks and turn OFF the meter before opening the case. Do not operate with open case. Install only the same type of fuse or equivalent

Calibration

Accuracy is specified for a period of one year after calibration. Periodic calibration at intervals of one year is recommended to maintain meter accuracy

Cleaning and Storage

Periodically wipe the meter and the test probe assembly with a damp cloth and mild detergent. Do not use abrasives or solvents. Allow to dry completely before operating. If the meter is not to be used for periods of longer than 60 days, remove the battery and store it separately

Trouble Shooting

If the instrument fails to operate, check battery, fuses, leads, etc., and replace as necessary. Double check operating procedure as described in this user's manual. Refer to the LIMITED WARRANTY section for obtaining warranty or repairing service.

Battery and Fuse replacement

Battery use: Four 1.5V AA alkaline batteries (IEC LR6)

Fuses use:

Fuse (F2) for “**INS. μ A mA**” input:

0.4A/1000Vac & Vdc, IR 30kA, F fuse; or better. Dimension: 6 x 32 mm

Fuse (F3) for “**A**” input:

11A/1000Vac & Vdc, IR 20kA, F fuse; or better. Dimension: 10 x 38 mm

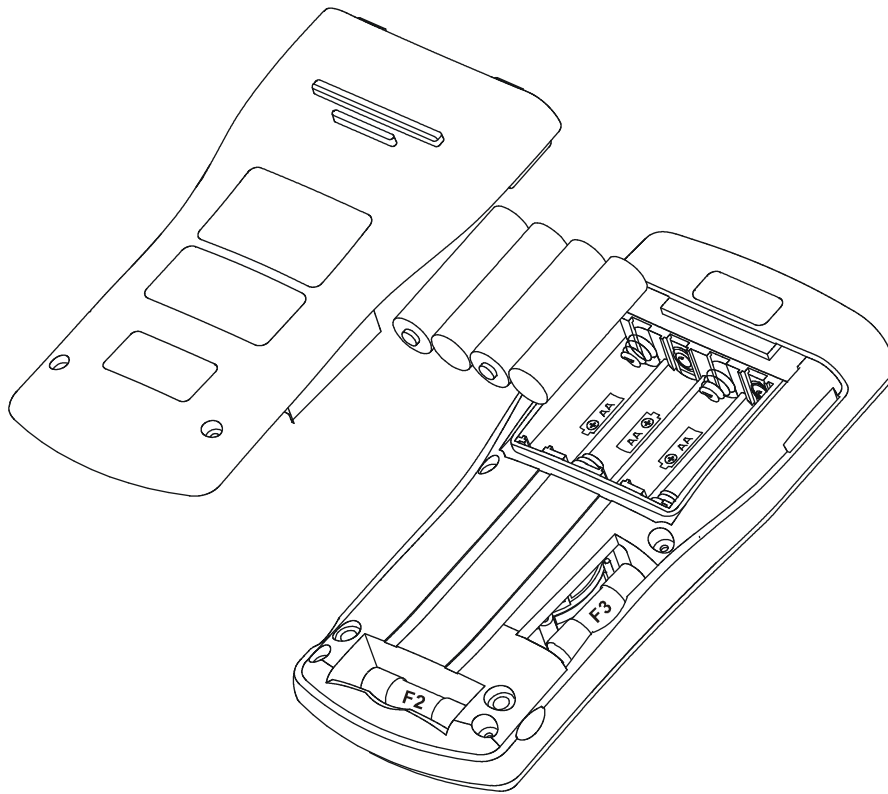

Battery and Fuse replacement:

Loosen the screws from the access cover of the case bottom. Lift the access cover. Replace the batteries or fuse. Re-fasten the screws.

GENERAL SPECIFICATION

Display: 3-5/6 digits 6,000 counts

Polarity: Automatic

Update Rate: 5 per second nominal

61 Segments Bar graph: 40 per second max

Operating Temperature: -10°C to 50°C

Relative Humidity: Maximum relative humidity 90% for temperature up to 28°C decreasing linearly to 50% relative humidity at 50°C

Pollution Degree: 2

IP Rating: IP40

Storage Temperature: -20°C to 60°C, < 80% R.H. (with battery removed)

Altitude: Operating below 2000m

Temperature Coefficient: nominal $0.1 \times (\text{specified accuracy}) / ^\circ\text{C} @ (-10^\circ\text{C} \sim 18^\circ\text{C} \text{ or } 28^\circ\text{C} \sim 50^\circ\text{C})$, or otherwise specified

Sensing: AC, True RMS

Safety: ETL certified per IEC/UL/EN61010-1 Ed. 3.0, IEC/UL/EN61010-2-030 Ed. 1.0, IEC/UL/EN61010-2-033 Ed. 1.0, IEC/UL/EN61010-031 Ed. 1.1 and the corresponding CAN/CSA-C22.2 regulations to Measurement Categories:

CAT III 1000 V AC & DC and Category IV 600V AC & DC

Compliance to IEC/EN61557:

IEC/EN61557-1 Ed. 2.0, IEC/EN61557-2 Ed. 2.0 & IEC/EN61557-10 Ed. 2.0

(Tested per CE requirements, not covered by ETL certification)

Overload Protections:

Insulation Resistance, μA & mA : 0.4A/1KV, IR 30kA, F Fuse; or better

A: 11A/1KV, IR 20kA, F Fuse; or better

V: 1100Vrms

mV, Ω & Others: 1000 Vrms

Transient Protection: 8kV (1.2/50 μs surge)

E.M.C.: Meets EN61326-1:2013

In an RF field of 3V/m:

Total Accuracy = Specified Accuracy + 25 digits

Performance above 3V/m is not specified

Power Supply: Four Alkaline AA batteries (IEC LR6)

Power Consumption: 6.5mA typical except the followings:

VFD ACV ^{+Hz}: 8mA

Insulation Resistance @1mA test current:

50V output voltage: 25mA

100V output voltage: 45mA
 250V output voltage: 85mA
 500V output voltage: 170mA
 1000V output voltage: 440mA

Tester can perform at least 950 insulation tests with new alkaline batteries at room temperature. These are standard tests of 1000 V into 1 M Ω with a duty cycle of 5 seconds on and 25 seconds off.

Low Battery: approx. 4.6V

APO Timing: Idle for 20 minutes

APO Consumption: 20 μ A typical

Dimension: L208mm X W103mm X H64.5mm with holster

Weight: 635 gm with holster

Accessories: Test probe pair, Alligator clip pair, BRP21S2-C Remote probe, Holster, User's manual, Bkp60 banana plug type-K thermocouple (Model 887 only)

Optional Accessories: BKB32 banana plug to type-K socket plug adaptor (Model 887 only), BMH-01 magnetic hanger; BMP-86x soft carrying pouch

Special Features: Record MAX/MIN regular readings; Relative Zero; Display Hold; LCD Backlight; VFD V & Hz readings; Dual display +Hz Readings; High resolution 60.00mV & 60.00 Ω ranges, Lock-Test mode for Insulation resistance; BeepJack™ audible & visible input warning

Electrical Specifications

Accuracy is \pm (% reading digits + number of digits) or otherwise specified, at 23°C \pm 5°C & less than 80% relative humidity.

True RMS voltage & current accuracies are specified from 1 % to 100 % of range or otherwise specified. Maximum Crest Factor < 1.8:1 at full scale & < 3.6:1 at half scale, and with frequency components fall within the specified frequency bandwidth for non-sinusoidal waveforms.

AC Voltage

RANGE	Accuracy	
	Model 887	Model 885
50Hz ~ 60Hz		
60.00mV ³⁾ , 600.0mV ⁴⁾ , 6.000V, 60.00V, 600.0V, 1000V	0.7% + 4d	0.7% + 4d
40Hz ~ 1kHz		
60.00mV ³⁾ , 600.0mV ⁴⁾ , 6.000V, 60.00V, 600.0V	1.3% + 4d	1.3% + 4d
1000V ⁵⁾	2% + 4d	2% + 4d
1kHz ~ 5kHz		
60.00mV ³⁾ , 600.0mV ⁴⁾ , 6.000V, 60.00V, 600.0V	2% + 4d ¹⁾	3% + 5d
1000V	Unspecified	
5kHz ~ 20kHz ²⁾		
60.00mV	Unspecified	
600.0mV ⁴⁾	2.5% + 20d ¹⁾	Unspecified
6.000V, 60.00V	2% + 20d ¹⁾	Unspecified
600.0V, 1000V	Unspecified	

Input impedance: 10M Ω , 110pF nominal

¹⁾Add 20d @ >80% of range

²⁾Unspecified @ <5% of range

³⁾Signal peak absolute values, including DC bias, less than 110mV_{peak}

⁴⁾Signal peak absolute values, including DC bias, less than 1100mV_{peak}

⁵⁾For model 885, unspecified at bandwidth > 500Hz

VFD AC Voltage

RANGE	Accuracy ¹⁾
10Hz ~ 45Hz	
600.0V	4.0% + 5d
45Hz ~ 200Hz	
600.0V	2.5% + 5d
200Hz ~ 440Hz	
600.0V	9.0% + 5d ²⁾

Input impedance: 10M Ω , 110pF nominal

¹⁾Unspecified for fundamental frequency > 440Hz

²⁾Accuracy linearly decreases from 2.5% + 5d @200Hz to 9.0% + 5d @440Hz

DC Voltage

RANGE	Accuracy	
	Model 887	Model 885
60.00mV	0.2% + 3d	0.3% + 3d
600.0mV, 6.000V, 60.00V	0.1% + 2d	0.2% + 2d
60.00mV, 600.0V, 1000V	0.2% + 3d	0.3% + 3d

Input impedance: 10M Ω , 110pF nominal

Ohms

RANGE ¹⁾	Accuracy	
	Model 887	Model 885
60.00 Ω ²⁾	0.5% + 5d	0.6% + 5d
600.0 Ω	0.2% + 3d	0.3% + 3d
6.000k Ω , 60.00k Ω	0.2% + 2d	0.3% + 2d
600.0k Ω	0.3% + 2d	0.4% + 2d
6.000M Ω ³⁾	1% + 3d	1.5% + 3d
60.00M Ω ⁴⁾	1.5% + 6d ^{5) 6)}	2% + 6d ^{5) 6)}

¹⁾Open Circuit Voltage: 1.7VDC typical

²⁾Specified assumes input lead resistance been offset by **RELA** or **Shrt** (short) feature

³⁾Constant Test Current: 0.2 μ A Typical

⁴⁾Constant Test Current: 0.02 μ A Typical

⁵⁾Add 1% @ >20M Ω

⁶⁾Add 2% @ operation temperature >35 $^{\circ}$ C

Audible Continuity Tester

Audible threshold: between 20 Ω and 350 Ω

Response time: < 30ms

Diode Tester

Range	Accuracy	Test Current (Typical)	Open Circuit Voltage
2.700V	1.5% + 4d	0.4mA	< 2.8 VDC

Capacitance (Model 887 only)

RANGE	Accuracy ¹⁾
2.000 μ F ²⁾ , 20.00 μ F, 200.0 μ F, 2000 μ F	1.5% + 5d
20.00mF	5% + 5d

¹⁾Accuracies with film capacitor or better

²⁾Specified from 0.200 μ F

Temperature (Model 887 only)

RANGE	Accuracy ^{1) 2)}
-40.0°C ~ 0.0°C	1% + 2°C
0.0°C ~ 50.0°C	2.2°C
50.0°C ~ 537.0°C	1% + 2°C
-40.0°F ~ 32.0°F	1% + 3.6°F
32.0°F ~ 122.0°F	4°F
122.0°F ~ 999.0°F	1% + 3.6°F

¹⁾Accuracies assume meter interior has the same temperature of the ambient (isothermal stage) for a correct junction voltage compensation. Allow enough time to reach the isothermal stage for a significant change of ambient temperature. It can take up to an hour for changes > 5°C.

²⁾Type-K thermocouple range & accuracy not included

DC current

RANGE	Accuracy		Burden Voltage
	Model 887	Model 885	
600.0 μ A ¹⁾	0.2% + 4d	0.4% + 4d	0.2mV/ μ A
6000 μ A ¹⁾	0.2% + 2d	0.4% + 2d	0.2mV/ μ A
60.00mA ¹⁾	0.2% + 4d	0.4% + 4d	3mV/mA
600.0mA ^{1) 2)}	0.3% + 3d	0.5% + 3d	3mV/mA
6.000A	0.5% + 4d	0.6% + 4d	30mV/A
10.00A ³⁾	0.7% + 2d	0.8% + 2d	30mV/A

¹⁾ μ A/mA DC accuracies will be affected by extreme interior temperatures of the meter. For rated accuracies, allow 6 to 20 minutes cool down interval after measuring A-currents of 3 to 10A continuously.

²⁾●400mA continuous; >400mA for <1.1 hours on per >20 minutes off

³⁾10A continuous up to ambient 35°C; <15 mins on per >5 mins off @ 35°C ~ 50°C. >10A to 20A for <30 seconds on per >5 mins off

AC current

RANGE	Accuracy		Burden Voltage
	Model 887	Model 885	
50Hz ~ 60Hz			
600.0μA, 6000μA	1% + 3d		0.2mV/μA
60.00mA, 600.0mA ¹⁾			3mV/mA
6.000A, 10.00A ²⁾			30mV/A
40Hz ~ 3kHz			
600.0μA, 6000μA	2% + 3d		0.2mV/μA
60.00mA, 600.0mA ¹⁾			3mV/mA
6.000A, 10.00A ²⁾			30mV/A
3kHz ~ 5kHz			
600.0μA, 6000μA	2% + 5d	Unspecified	0.2mV/μA
60.00mA, 600.0mA ¹⁾			3mV/mA
6.000A, 10.00A ²⁾	Unspecified		30mV/A

¹⁾ ●400mA continuous; >400mA for <1.1 hours on per >20 minutes off

²⁾10A continuous up to ambient 35°C; <15 mins on per >5 mins off @ 35°C ~ 50°C.
>10A to 20A for <30 seconds on per >5 mins off

~ Hz Line Level Frequency

Function RANGE	Sensitivity (Sine RMS)	Range
60mV	4mV	6Hz ~ 50kHz
600mV	40mV	10Hz ~ 100kHz
6V	0.4V	10Hz ~ 50kHz
60V	4V	
600V	40V	10Hz ~ 30kHz
1000V	400V	10Hz ~ 5kHz
VFD 600V	40V	10Hz ~ 440Hz
600μA	40μA	10Hz ~ 5kHz
6000μA	400μA	
60mA	4mA	
600mA	40mA	
6A	0.6A	10Hz ~ 3kHz
10A	6A	

Accuracy: 0.02%+4d

Record mode

This mode records standard measurement Max and Min readings on most functions, Manual or Auto-ranging where available.

Nominal response and accuracy: Same as standard measurements

Insulation Resistance

Test Voltage ¹⁾	Range	Test Current	Accuracy
50V	3.000MΩ, 30.00MΩ, 55.0MΩ	1mA @50kΩ	1.5%+5d
100V	3.000MΩ, 30.00MΩ, 110.0MΩ	1mA @100kΩ	
250V	3.000MΩ, 30.00MΩ, 275.0MΩ	1mA @250kΩ	
500V	3.000MΩ, 30.00MΩ, 300.0MΩ, 550.0MΩ	1mA @500kΩ	
1000V	3.000MΩ, 30.00MΩ, 300.0MΩ	1mA @1MΩ	1.5%+5d
	3000MΩ		2.0%+5d
	25.0GΩ		10%+5d

¹⁾Actual output voltage: 100% ~ 120% of Test Voltage

Live Circuit Detector: Inhibit test and display voltage reading instead if terminal voltage > 30V prior to initialization of test. Display voltage accuracies:

DCV: 1.5% + 5d

ACV: 3.0% + 5d @50Hz ~ 60Hz

Specified measuring range is 0.020MΩ ... 25.0GΩ for percentage operating uncertainty B[%] ● ±30% per IEC/EN61557-2 requirements

LIMITED WARRANTY

BRYMEN warrants to the original product purchaser that each product it manufactures will be free from defects in material and workmanship under normal use and service within a period of one year from the date of purchase. BRYMEN's warranty does not apply to accessories, fuses, fusible resistors, spark gaps, varistors, batteries or any product which, in BRYMEN's opinion, has been misused, altered, neglected, or damaged by accident or abnormal conditions of operation or handling.

To obtain warranty service, contact your nearest BRYMEN authorized agent or send the product, with proof of purchase and description of the difficulty, postage and insurance prepaid, to BRYMEN TECHNOLOGY CORPORATION. BRYMEN assumes no risk for damage in transit. BRYMEN will, at its option, repair or replace the defective product free of charge. However, if BRYMEN determines that the failure was caused by misused, altered, neglected, or damaged by accident or abnormal conditions of operation or handling, you will be billed for the repair.

THIS WARRANTY IS EXCLUSIVE AND IS IN LIEU OF ALL OTHER WARRANTIES, EXPRESSED OR IMPLIED, INCLUDING BUT NOT LIMITED TO ANY IMPLIED WARRANTY OR MERCHANTABILITY OR FITNESS FOR A PARTICULAR PURPOSE OR USE. BRYMEN WILL NOT BE LIABLE FOR ANY SPECIAL, INDIRECT, INCIDENTAL OR CONSEQUENTIAL DAMAGES.



BRYMEN TECHNOLOGY CORPORATION

TEL:+886 2 2226 3396

FAX:+886 2 2225 0025

<http://www.brymen.com>



PRINTED ON RECYCLABLE PAPER, PLEASE RECYCLE

COPYRIGHT © MMXVI BTC, ALL RIGHTS RESERVED

P/N: 7M1C-1481-A000

PRINTED IN TAIWAN